

MBRF20200CTG

Switch-mode Schottky Power Rectifier

The Switch-mode Power Rectifier employs the Schottky Barrier principle in a large area metal-to-silicon power diode. State-of-the-art geometry features epitaxial construction with oxide passivation and metal overlay contact. Ideally suited for use as rectifiers in very low-voltage, high-frequency switching power supplies, free wheeling diodes and polarity protection diodes.

Features

- Highly Stable Oxide Passivated Junction
- Very Low Forward Voltage Drop
- Matched Dual Die Construction
- High Junction Temperature Capability
- High dv/dt Capability
- Guardring for Stress Protection
- Epoxy Meets UL 94 V-0 @ 0.125 in
- Electrically Isolated. No Isolation Hardware Required.
- These Devices are Pb-Free and are RoHS Compliant

Mechanical Characteristics:

- Case: Epoxy, Molded
- Weight: 1.9 Grams (Approximately)
- Finish: All External Surfaces Corrosion Resistant and Terminal Leads are Readily Solderable
- Lead Temperature for Soldering Purposes: 260°C Max. for 10 Seconds



ON Semiconductor®

www.onsemi.com

**SCHOTTKY BARRIER
RECTIFIER
20 AMPERES, 200 VOLTS**

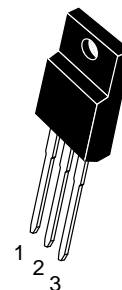
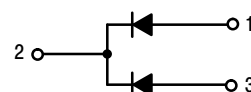

TO-220 FULLPAK
CASE 221AH

MARKING DIAGRAM

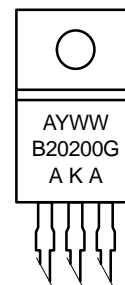

A = Assembly Location
Y = Year
WW = Work Week
B20200 = Device Code
G = Pb-Free Package
AKA = Polarity Designator

ORDERING INFORMATION

Device	Package	Shipping
MBRF20200CTG	TO-220 (Pb-Free)	50 Units/Rail

*For additional information on our Pb-Free strategy and soldering details, please download the ON Semiconductor Soldering and Mounting Techniques Reference Manual, SOLDERRM/D.

MBRF20200CTG

MAXIMUM RATINGS (Per Leg)

Rating	Symbol	Value	Unit
Peak Repetitive Reverse Voltage Working Peak Reverse Voltage DC Blocking Voltage	V_{RRM} V_{RWM} V_R	200	V
Average Rectified Forward Current (Rated V_R) $T_C = 125^\circ\text{C}$	$I_{F(AV)}$	10 20	A Per Leg Per Package
Peak Repetitive Forward Current, Per Leg (Rated V_R , Square Wave, 20 kHz) $T_C = 90^\circ\text{C}$	I_{FRM}	20	A
Nonrepetitive Peak Surge Current (Surge applied at rated load conditions halfwave, single phase, 60 Hz)	I_{FSM}	150	A
Peak Repetitive Reverse Surge Current (2.0 μs , 1.0 kHz)	I_{RRM}	1.0	A
Operating Junction Temperature and Storage Temperature	T_J, T_{stg}	-65 to +150	$^\circ\text{C}$
Voltage Rate of Change (Rated V_R)	dv/dt	10,000	V/ μs

Stresses exceeding those listed in the Maximum Ratings table may damage the device. If any of these limits are exceeded, device functionality should not be assumed, damage may occur and reliability may be affected.

THERMAL CHARACTERISTICS (Per Leg)

Rating	Symbol	Value	Unit
Thermal Resistance, Junction-to-Case	$R_{\theta JC}$	3.5	$^\circ\text{C/W}$

ELECTRICAL CHARACTERISTICS (Per Leg)

Rating	Symbol	Max	Unit
Maximum Instantaneous Forward Voltage (Note 1) ($i_F = 10$ Amp, $T_C = 25^\circ\text{C}$) ($i_F = 10$ Amp, $T_C = 125^\circ\text{C}$) ($i_F = 20$ Amp, $T_C = 25^\circ\text{C}$) ($i_F = 20$ Amp, $T_C = 125^\circ\text{C}$)	V_F	0.9 0.8 1.0 0.9	V
Maximum Instantaneous Reverse Current (Note 1) (Rated dc Voltage, $T_C = 25^\circ\text{C}$) (Rated dc Voltage, $T_C = 125^\circ\text{C}$)	i_R	1.0 50	mA

DYNAMIC CHARACTERISTICS (Per Leg)

Capacitance ($V_R = -5.0$ V, $T_C = 25^\circ\text{C}$, Freq. = 1.0 MHz)	C_T	500	pF
---	-------	-----	----

1. Pulse Test: Pulse Width = 300 μs , Duty Cycle $\leq 2.0\%$

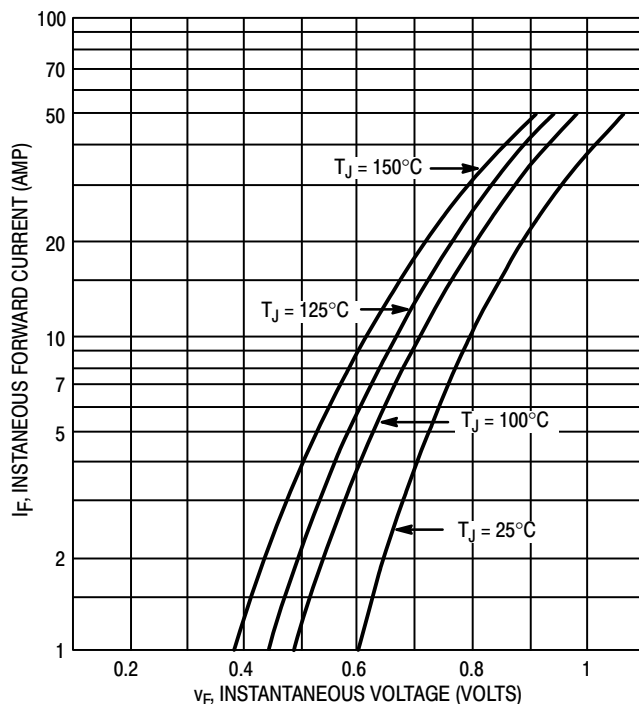

Figure 1. Typical Forward Voltage (Per Leg)

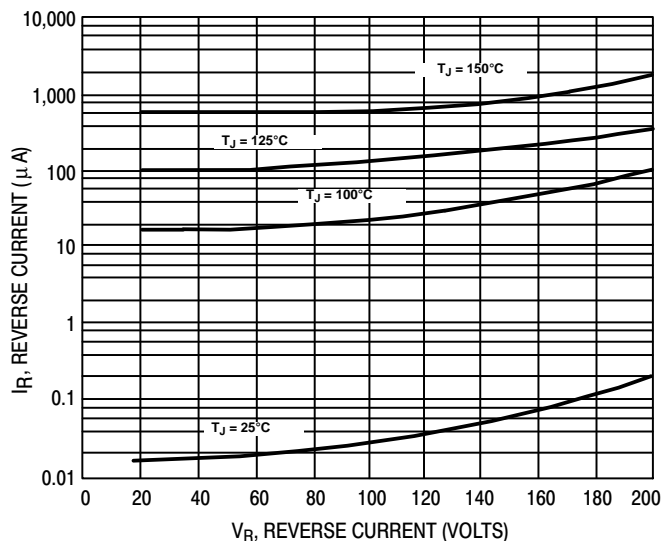

Figure 2. Typical Reverse Current (Per Leg)

MBRF20200CTG

TEST CONDITION FOR ISOLATION TEST*

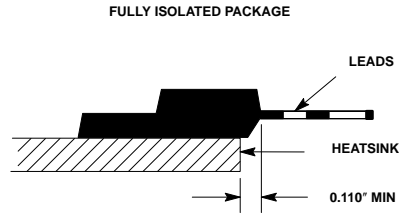
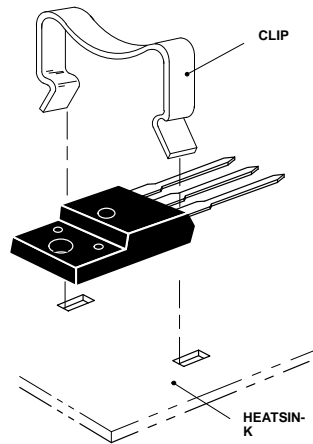

Figure 3. Mounting Position

*Measurement made between leads and heatsink with all leads shorted together.

MOUNTING INFORMATION



Clip-Mounted

Figure 4. Typical Mounting Technique

MBRF20200CTG

PACKAGE DIMENSIONS

TO-220 FULLPACK, 3-LEAD CASE 221AH ISSUE F

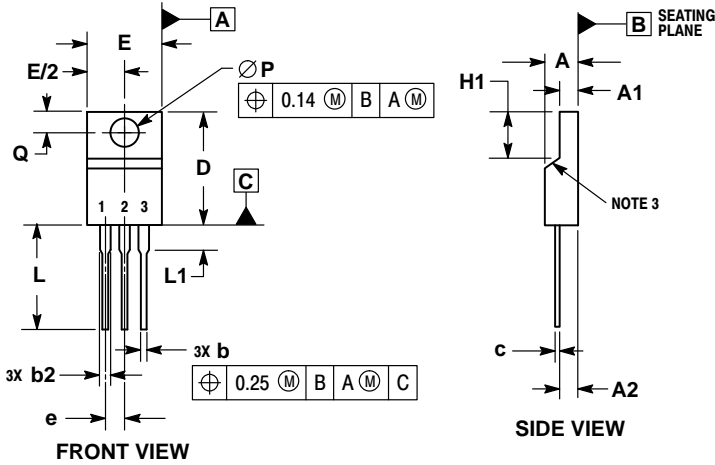

- NOTES:
1. DIMENSIONING AND TOLERANCING PER ASME Y14.5M, 1994.
 2. CONTROLLING DIMENSION: MILLIMETERS.
 3. CONTOUR UNCONTROLLED IN THIS AREA.
 4. DIMENSIONS D AND E DO NOT INCLUDE MOLD FLASH AND GATE PROTRUSIONS. MOLD FLASH AND GATE PROTRUSIONS NOT TO EXCEED 0.13 PER SIDE. THESE DIMENSIONS ARE TO BE MEASURED AT OUTERMOST EXTREME OF THE PLASTIC BODY.
 5. DIMENSION b2 DOES NOT INCLUDE DAMBAR PROTRUSION. LEAD WIDTH INCLUDING PROTRUSION SHALL NOT EXCEED 2.00.
 6. CONTOURS AND FEATURES OF THE MOLDED PACKAGE BODY MAY VARY WITHIN THE ENVELOPE DEFINED BY DIMENSIONS A1 AND H1 FOR MANUFACTURING PURPOSES.

MILLIMETERS		
DIM	MIN	MAX
A	4.30	4.70
A1	2.50	2.90
A2	2.50	2.90
b	0.54	0.84
b2	1.10	1.40
c	0.49	0.79
D	14.70	15.30
E	9.70	10.30
e	2.54 BSC	
H1	6.60	7.10
L	12.50	14.73
L1	---	2.80
P	3.00	3.40
Q	2.80	3.20

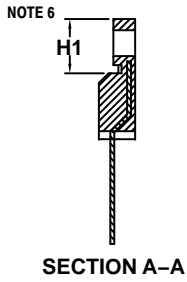
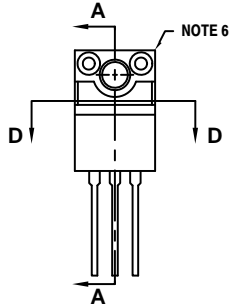
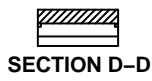

ON Semiconductor and the are registered trademarks of Semiconductor Components Industries, LLC (SCILLC) or its subsidiaries in the United States and/or other countries. SCILLC owns the rights to a number of patents, trademarks, copyrights, trade secrets, and other intellectual property. A listing of SCILLC's product/patent coverage may be accessed at www.onsemi.com/site/pdf/Patent-Marking.pdf. SCILLC reserves the right to make changes without further notice to any products herein. SCILLC makes no warranty, representation or guarantee regarding the suitability of its products for any particular purpose, nor does SCILLC assume any liability arising out of the application or use of any product or circuit, and specifically disclaims any and all liability, including without limitation special, consequential or incidental damages. "Typical" parameters which may be provided in SCILLC data sheets and/or specifications can and do vary in different applications and actual performance may vary over time. All operating parameters, including "Typicals" must be validated for each customer application by customer's technical experts. SCILLC does not convey any license under its patent rights nor the rights of others. SCILLC products are not designed, intended, or authorized for use as components in systems intended for surgical implant into the body, or other applications intended to support or sustain life, or for any other application in which the failure of the SCILLC product could create a situation where personal injury or death may occur. Should Buyer purchase or use SCILLC products for any such unintended or unauthorized application, Buyer shall indemnify and hold SCILLC and its officers, employees, subsidiaries, affiliates, and distributors harmless against all claims, costs, damages, and expenses, and reasonable attorney fees arising out of, directly or indirectly, any claim of personal injury or death associated with such unintended or unauthorized use, even if such claim alleges that SCILLC was negligent regarding the design or manufacture of the part. SCILLC is an Equal Opportunity/Affirmative Action Employer. This literature is subject to all applicable copyright laws and is not for resale in any manner.

PUBLICATION ORDERING INFORMATION

LITERATURE FULFILLMENT:
Literature Distribution Center for ON Semiconductor
P.O. Box 5163, Denver, Colorado 80217 USA
Phone: 303-675-2175 or 800-344-3860 Toll Free USA/Canada
Fax: 303-675-2176 or 800-344-3867 Toll Free USA/Canada
Email: orderlit@onsemi.com

N. American Technical Support: 800-282-9855 Toll Free
USA/Canada
Europe, Middle East and Africa Technical Support:
Phone: 421 33 790 2910
Japan Customer Focus Center
Phone: 81-3-5817-1050

ON Semiconductor Website: www.onsemi.com
Order Literature: <http://www.onsemi.com/orderlit>
For additional information, please contact your local Sales Representative